

MAGURIT

GEFRIERSCHNEIDER GMBH

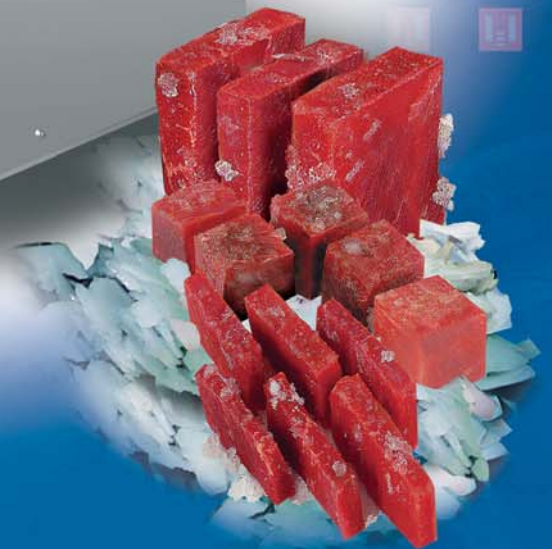

GUILLOTINEN-
SCHNEIDSYSTEM
GUILLOTINE-CUTTER

UNICUT 584





Unicut 584

Der **UNICUT 584** vereint das robuste Schneiden eines Gefrierschneiders mit modernster Fördertechnik, und wird für Anwendungen eingesetzt, wo hohe Leistungen bei genauem Schnittbild verlangt werden. Dazu wird das Produkt mit einem gesteuerten Förder- und Niederhalterband dem Messerkopf zugeführt. Dies ermöglicht eine präzise Längen - Kalibrierung, und erlaubt den Einsatz neuester Schneid-geometrien.

 The **UNICUT 584** combines the necessary strong cutting of a frozen block cutter with most modern feeding technology, and is used for applications where a precise cutting combined with high volumes is needed. Controlled in-feed and down-holding conveyors forward the product to the cutting area. This allows length calibration of the product, and the use of newest blade developments.

 L'**UNICUT 584** allie la coupe puissante d'une guillotine à congelé avec les techniques les plus modernes d'amenée de matières vers le système de coupe, et permet ses applications partout où l'on nécessite des capacités élevées ainsi qu'une coupe précise et parfaite. Pour cela, le produit est amené dans le système de coupe par un tapis de transport et un tapis de maintien réglables. Ceci permet un calibrage précis de la longueur et autorise son application dans de nouvelles géométries de coupe.

 La **UNICUT 584** combina el corte potente que requiere una guillotina de bloques congelados con la tecnología de alimentación más moderna. Se utiliza para aplicaciones que requieren un corte preciso en combinación con altas capacidades. La cinta transportadora inferior y la cinta superior de fijación acompañan el producto hasta la zona de corte de manera controlada, permitiendo la calibración de la longitud del producto y la utilización de los novedosos desarrollos en cuchillas.



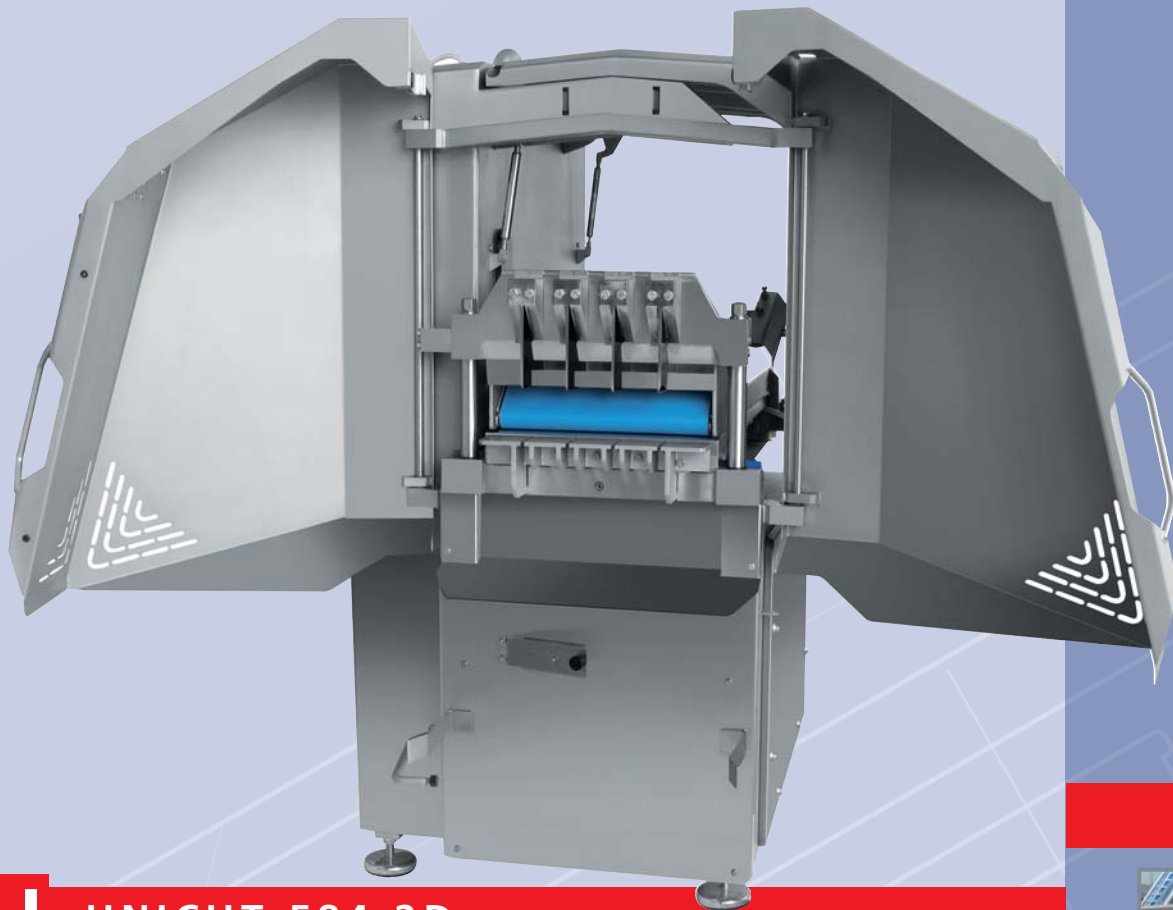

 La **UNICUT 584** combina la necessaria potenza di taglio di una trancia per blocchi di congelato con le più moderne tecnologie di avanzamento del prodotto, e viene utilizzata per quelle applicazioni dove è richiesto un taglio preciso insieme ad un'alta produttività. Una alimentazione controllata e un nastro ferma-blocco guidano il prodotto verso la zona di taglio. Ciò consente una accurata calibratura della lunghezza e l'ottenimento delle più nuove geometrie di taglio.









UNICUT 584 2D





Gefriergutzerkleinerung für Auftautumbler bei Kochschinkenherstellung

-  *frozen block reduction for defrosting in tumblers for cooked ham production*
-  *Réduction de matières congelées pour la production de jambons cuits dans des barattes de décongélation.*
-  *Reducción de bloques congelados para descongelar en bombos en la producción de jamón cocido.*
-  *Riduzione di dimensione dei blocchi per lo scongelamento in zangola destinati alla produzione di prosciutto cotto*

Längenportionierung per Lichtschanke für SB Verpackung (optional)

-  *Length Control by light barrier (optional)*
-  *Calibrage à la longueur par photo cellule pour les emballages L.S.*
-  *Control de la longitud del producto mediante fotocélula*
-  *Controllo Lunghezza*

Rohschinkenzerkleinerung für Würfelherstellung

-  *Raw ham for the production of diced Ham*
-  *Cubage de jambons crus*
-  *Precorte de Jamón curado para la producción de dados y tiras de carne*
-  *Prosciutto crudo per la produzione di cubetti*



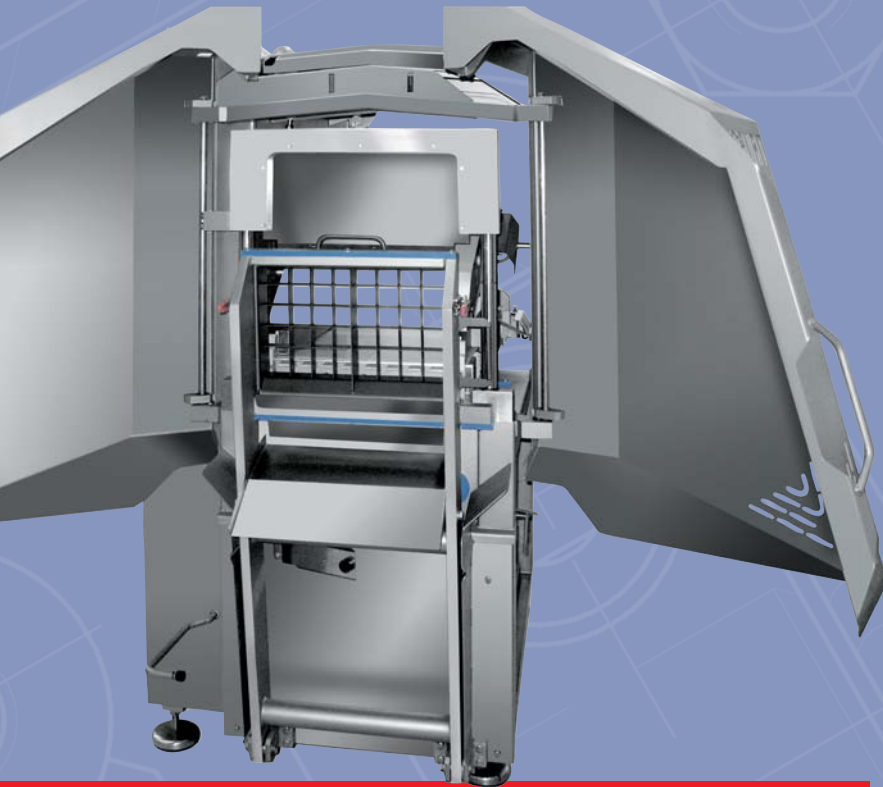



UNICUT 584 3D



Der **UNICUT 584 3D** wurde speziell für die Verarbeitung von Käseblöcken oder -laiben zur Herstellung von Reibekäse entwickelt. Dabei schneidet der UNICUT 584 aus den Blöcken dreidimensional Würfel mit dem Kundenwunsch entsprechenden Kantenlängen zwischen 25 und 50 mm. Durch diese Vorzerkleinerung der Käseblöcke sind die im anschließenden Reibeprozess entstehenden Käsestücke ideal für die automatische Bestreuung von Pizzen, Baguettes oder anderer Al Forno Gerichte

 The **UNICUT 584 3D** was specifically designed for high speed dicing of cheese blocks for the grated cheese industry. The machine cuts three-dimensional dices between 25 to 50 mm, according to customers' requirements. By choosing the correct cutting grid and adjusting the feeding speed to control the length, all three dimensions can be adjusted separately. Utilising this precise control system we can guarantee that the cheese pieces are the correct size for sprinkling onto such products as Pizza, Baguettes, Lasagnas or any other "al Forno" products.

 L'**UNICUT 584 3D** a été spécialement conçu pour la transformation de blocs ou de meules de fromage pour la production de fromage râpé. Pour ceci, l'**UNICUT 584** coupe, à partir de blocs, des cubes tridimensionnels selon le souhait des clients de 25 à 50 mm de côté. Du fait de cette pré – réduction, les process de râpage produisent des morceaux de fromage idéaux pour le saupoudrage automatique de pizzas, baguettes ou autres produits gratinés.

 La **UNICUT 584 3D** fue especialmente diseñada para el corte a gran velocidad de dados a partir de bloques de queso en la industria de queso rallado. La máquina corta dados de tres dimensiones entre 25 y 50 mm, en función de las necesidades de cada cliente. Las tres dimensiones se ajustan independientemente mediante la elección de la parrilla de corte y la regulación de la velocidad de alimentación para controlar la longitud. Mediante este sistema de control preciso, podemos garantizar que las piezas de queso tienen la medida correcta para su dosificación sobre productos tales como Pizzas, Baguettes, Lasagnas u otro tipo de productos.

 La **UNICUT 584 3D** è stata specificamente progettata per il taglio ad alta velocità di blocchi di formaggio destinati alla produzione di prodotto grattugiato. La macchina taglia cubetti di lato compreso tra 25 e 50 mm., secondo le necessità del cliente. Scegliendo la griglia di taglio adatta e regolando la velocità di alimentazione che determina la lunghezza, le tre dimensioni del cubetto possono essere variate separatamente. Utilizzando questo accurato sistema di taglio possiamo garantire la dimensione ideale dei pezzi di formaggio per una grande varietà di prodotti come Pizza, Baguette, Lasagne qualunque altro prodotto da Forno.

Ein kontinuierlicher Produktionsablauf reduziert den Arbeitsaufwand, spart Kosten und sichert einen hygienischen Umgang mit dem Produkt. MAGURIT bietet das nötige Zubehör:

Der UNI-PALLI hebt ganze Paletten von gefrorenen Blöcken auf eine ergonomische Arbeitshöhe an, so dass ein schnelles und verletzungsfreies Arbeiten für den Maschinenbediener möglich ist. Die Förderschneckensysteme MAGCON und MAGURAFFE fördern das geschnittene Produkt kontinuierlich, je nach Bedarf, in Mischer oder Wölfe. Ein manueller Eingriff ist nicht mehr nötig.

 The transfer of raw product be it fresh or frozen to production equipment is a critical part of any process line, reducing manual labour and double handling of product, therefore ensuring hygienic product transfer. Magurit offers the following accessories which can be used inline with our equipment. The UNI-PALLI is designed to lift whole pallets of frozen material to a safe working height, reducing the possibility of operator injury caused by lifting heavy blocks. The MAGCON and MAGURAFFE are vertical and angled continuous screw systems for transferring product from our machines directly into grinders or mixers depending on the process in question, removing the need for manual intervention.

 Une production en continu réduit le temps de travail et réduit les coûts de production tout en préservant le produit. MAGURIT propose également avec cette machine 1 UNI – PALLI qui soulève les palettes complètes jusqu'à une hauteur désirée, de façon à pouvoir glisser les blocs sur la table. Pour l'évacuation des produits, MAGURIT propose également un système MAGCON ou MAGURAFFE pour le transfert des produits grignotés.

 La transferencia de la materia prima a los equipos de producción, fresca o congelada, es una parte crítica en cualquier línea de producción, reduciendo mano de obra y doble manipulación del producto, asegurando así una transferencia higiénica del producto. Magurit ofrece los siguientes accesorios que pueden usarse en línea con nuestros equipos. El UNI-PALLI está diseñado para elevar palets enteros de material congelado a una altura de trabajo segura, reduciendo la posibilidad de lesiones del operario causadas por la elevación de bloques pesados.

El MAGCON y MAGURAFFE son sistemas verticales e inclinados de sinfín para la transferencia de producto directamente desde nuestras máquinas a picadoras o mezcladoras, en función del proceso en cuestión, sustituyendo así la necesidad de una intervención manual.

 Il trasferimento della materia prima, sia essa fresca o congelata, ai macchinari di lavorazione è una parte critica di ogni linea di processo, in quanto consente di ridurre la manipolazione e le ripetizioni di movimentazioni del prodotto, assicurandone l'igienicità. Magurit offre i seguenti accessori che possono essere messi in linea con i nostri macchinari.

UNI-PALLI è progettato per il sollevamento sicuro alla giusta altezza di lavoro di interi pallets di materiale congelato, riducendo la possibilità di infortuni all'operatore causati dal sollevamento di pesanti blocchi.

MAGCON e MAGURAFFE sono sistemi verticali e angolari a vite continua per il trasferimento del prodotto dalle nostre macchine direttamente, in funzione del tipo di lavorazione, ai tritacarne o ai mescolatori, rendendo inutile l'intervento manuale dell'operatore.



MAGCON



MAGURAFFE



MAGCON



UNI-PALLI

MAGURIT

Technische Daten / Technical data /
fiche techniques / Datos técnicos / Dati tecnici:

Anschlußleistung / Electrical power / L'alimentation électrique / Potencia / Potenza di ingresso:	6,5 kW	8,7 hp
Verarbeitungstemperatur / Processing temperature Température de travail / temperatura de procesamiento temperatura di lavorazione:	584 3D >0° C. 584 2D bis -25°C	>32° F. Min. -10°F.
Länge/ Length / Longueur / Largo / Lunghezza:	3248 mm	127-7/8"
Breite/ Width / Largeur / Ancho / Larghezza:	1034 mm	40-3/4"
Höhe/ Height / Hauteur / Alto / Altezza:	2135 mm	84"
Schneidraumaß / Cutting area dimensions: Capacité de coupe / medida de procesamiento / misura de elaborazione:	480 mm x 240 mm x ∞	18-3/4" x 9-3/8" x ∞

Änderungen vorbehalten / Subject to alterations / Sous réserve de modifications

Unicut 584 2D/ 3D

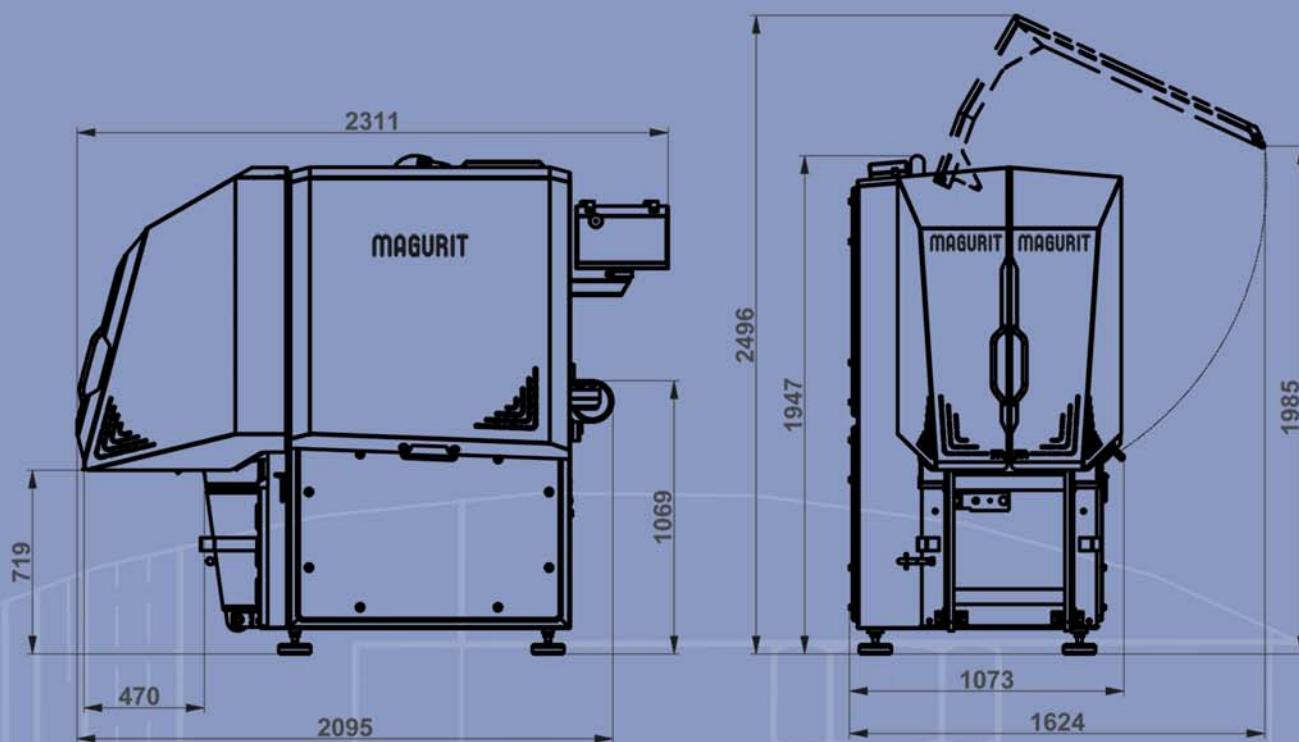

MAGURIT

MAGURIT Gefrierschneider GmbH
Höhenweg 91
D-42897 Remscheid
Telefon: +49 (0)2191/ 96 62-0
Telefax: +49 (0)2191/ 96 62-98
magurit@magurit.de
www.magurit.de